

Digital Automatic Blood Pressure Monitor Model M2

- Instruction Manual
- Mode d'emploi
- Gebrauchsanweisung
- Manuale di istruzioni
- Manual de instrucciones
- Gebruiksaanwijzing
- Руководство по эксплуатации

• كتيب الإرشادات

EN

FR

DE

IT

ES

NL

RU

AR

Contents

Before using the unit

Introduction	3
Important Safety Information.....	4
1. Overview	7
2. Preparation	9
2.1 Installing/Replacing the Batteries.....	9

Operating instructions

3. Using the Unit.....	11
3.1 How to Sit Correctly When Taking a Measurement	11
3.2 Applying the Arm Cuff	13
3.3 Taking a Reading.....	15
3.4 Instructions for Special Conditions.....	20
3.5 Using the Memory Function	21
4. Quick Reference Guide	23

Care and maintenance

5. Handling Errors and Problems	24
5.1 Error Messages.....	24
5.2 Troubleshooting	26
6. Maintenance and Storage	28
7. Optional Parts	30
8. Technical Data.....	31
9. Some Useful Information about Blood Pressure	33

Introduction

Thank you for purchasing the OMRON M2 Upper Arm Blood Pressure Monitor.

The OMRON M2 is a fully automatic blood pressure monitor, operating on the oscillometric principle. It measures your blood pressure and pulse rate simply and quickly. For comfortable controlled inflation without the need of pressure pre-setting or re-inflation the device uses its advanced “IntelliSense” technology.

The unit also stores up to 21 measurements in memory.

Intended Use

This product is designed to measure the blood pressure and pulse rate of people within the range of the designated arm cuff, following the instructions in this instruction manual.

It is mainly designed for general household use. Please read the Important Safety Information in this instruction manual before using the unit.



Please read this instruction manual thoroughly before using the unit. For specific information about your own blood pressure, CONSULT YOUR DOCTOR.

EN

Important Safety Information

Consult your doctor prior to using in pregnancy or if diagnosed with arrhythmia or arteriosclerosis.

Please read this section carefully before using the unit.

⚠ Warning:

- Indicates a potentially hazardous situation which, if not avoided, could result in death or serious injury.

(General Usage)

- Always consult your doctor. Self-diagnosis of measurement results and self-treatment are dangerous.
- People with severe blood flow problems, or blood disorders, should consult a doctor before using the unit, as cuff inflation can cause internal bleeding.

(AC Adapter Usage)

- Never plug in or unplug the power cord from the electric outlet with wet hands.

(Battery Usage)

- If battery fluid should get in your eyes, immediately rinse with plenty of clean water. Consult a doctor immediately.

⚠ Caution:

- Indicates a potentially hazardous situation which, if not avoided, may result in minor or moderate injury to the user or patient or damage to the equipment or other property.

(General Usage)

- Do not leave the unit unattended with infants or persons who cannot express their consent.
- Do not use the unit for any purpose other than measuring blood pressure.
- Do not disassemble the unit or arm cuff.
- Use only the approved arm cuff for this unit. Use of other arm cuffs may result in incorrect measurement results.
- Make sure that the air tube is not wrapped around other parts of your body when taking measurements. This could result in injury when the air pressure in the air tube is increased.

- Do not leave the cuff wrapped on the arm if taking measurements during the night. This could result in injury.
- Do not inflate the arm cuff over 299 mmHg.
- Do not use a mobile phone or other devices that emit electromagnetic fields, near the unit. This may result in incorrect operation of the unit.
- Do not operate the unit in a moving vehicle (car, airplane).
- To inflate the cuff manually, refer to Chapter 3.4. If the cuff is over inflated, it can cause internal bleeding.

(AC Adapter Usage)

- Use only the original AC adapter (optional) designed for this unit. Use of unsupported adapters may damage and/or may be hazardous to the unit.
- Plug the AC adapter into the appropriate voltage outlet.
- Do not use the AC adapter if the unit or the power cord is damaged. Turn off the power and unplug the power cord immediately.

(Battery Usage)

- If battery fluid should get on your skin or clothing, immediately rinse with plenty of clean water.
- Use only four “AAA” alkaline batteries with this unit. Do not use other types of batteries.
- Do not insert the batteries with their polarities incorrectly aligned.
- Replace old batteries with new ones immediately. Replace all four batteries at the same time.
- Remove the batteries if the unit will not be used for three months or more.
- Do not use new and used batteries together.

General Precautions

- Do not apply strong shocks and vibrations to or drop the unit and arm cuff.
- Do not take measurements after bathing, drinking alcohol, smoking, exercising or eating.
- Do not forcibly bend the arm cuff or bend the air tube excessively.
- When removing the air tube, pull on the air plug at the connection with the main unit not the tube itself.
- Do not inflate the arm cuff when it is not wrapped around your arm.

Important Safety Information

- Do not wash the arm cuff or immerse it in water.
- Read and follow the “Important information regarding Electro Magnetic Compatibility (EMC)” in the Technical Data Section.
- Read and follow the “Correct Disposal of This Product” in the Technical Data Section when disposing of the device and any used accessories or optional parts.

1. Overview

Main Unit

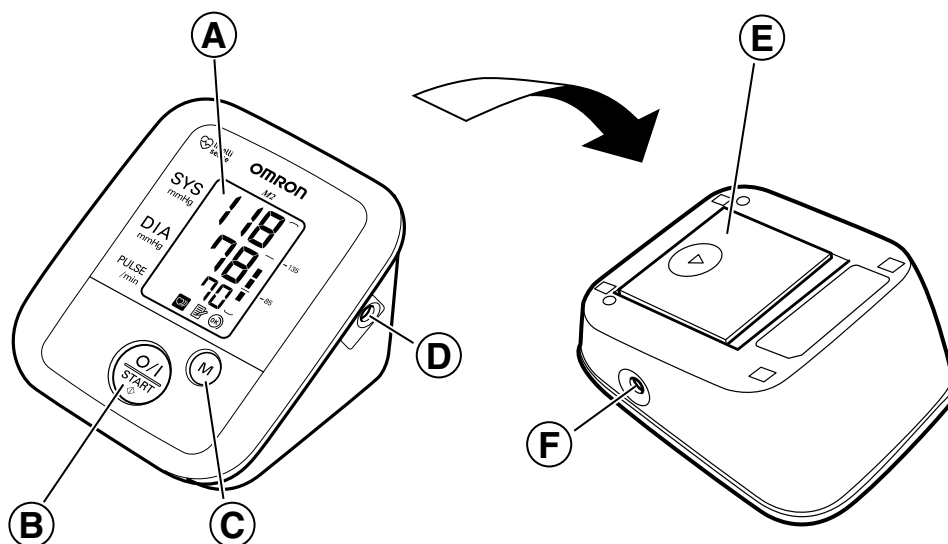

- A. Display
- B. O/I START button
- C. M (Memory) button
- D. AC adapter jack (for optional AC adapter)
- E. Battery compartment
- F. Air jack

Arm Cuff

EN

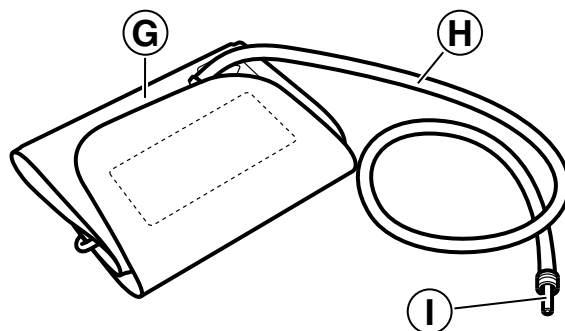

- G. Arm cuff
(Medium cuff: arm circumference 22-32 cm)
- H. Air tube
- I. Air plug

Display

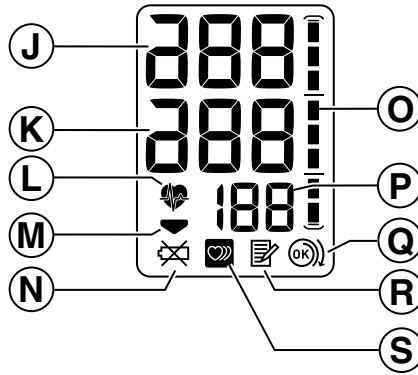

- | | |
|---|-----------------------------------|
| J. Systolic blood pressure | O. Blood pressure level indicator |
| K. Diastolic blood pressure | P. Pulse display |
| L. Heartbeat symbol
(Flashes during measurement) | Q. Cuff wrapping guide |
| M. Deflation symbol | R. Memory symbol |
| N. Battery low symbol | S. Irregular heartbeat symbol |

Package Contents (others)

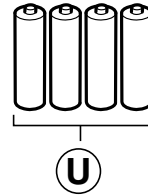
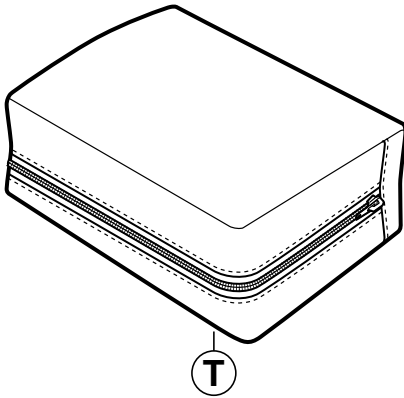

- | | |
|---|-----------------------|
| T. Storage case | • Instruction manual |
| U. Four "AAA" alkaline (LR03) batteries | • Guarantee card |
| | • Blood pressure pass |

2. Preparation

2.1 Installing/Replacing the Batteries

1. Turn the main unit upside down.

2. Slide the battery cover in the direction of the arrow while pressing the ribbed part of the cover.

3. Install or replace four “AAA” size batteries so that the + (positive) and - (negative) polarities match the polarities indicated on the battery compartment.

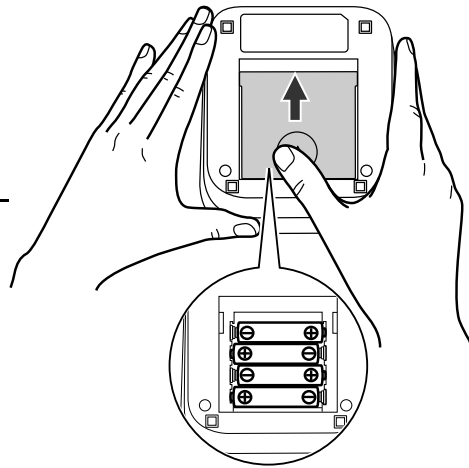

4. Put the battery cover back in place.

Slide the battery cover as indicated, until it clicks into place.

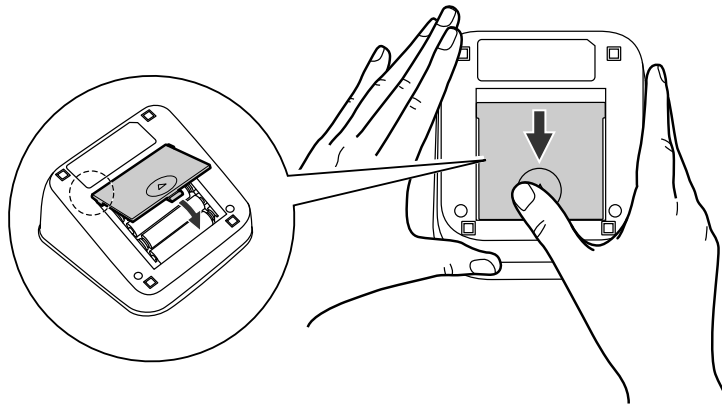



EN

Note: The measurement values continue to be stored in memory even after the batteries are replaced.

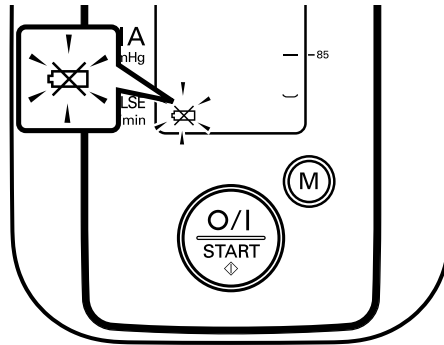
Battery Life & Replacement



If the battery low symbol () appears on the display, replace all four batteries at the same time.

- When the battery low symbol () starts to blink, you will still be able to use the unit for a short while. You should replace the batteries with new ones as soon as possible.
- When the symbol () remains lit, the batteries are exhausted. You should replace the batteries with new ones at once. Turn the unit off before replacing the batteries.
- Remove the batteries if the unit will not be used for three months or more.
- Dispose of batteries according to applicable local regulations.

Four new “AAA” alkaline batteries will last for approximately 300 measurements, when used to take two measurements a day.

Since the supplied batteries are for monitoring use only, they may have a shorter life and do not last for 300 measurements.

3. Using the Unit

3.1 How to Sit Correctly When Taking a Measurement

Correct posture during measurement is necessary to get accurate results.

Notes:

- Measurements should be taken in a quiet place and you should be in a relaxed, seated position. Make sure that the room is not too hot or too cold.
- Avoid eating, drinking alcohol, smoking, or exercising for at least 30 minutes before taking a measurement.
- Do not move or talk during measurement.

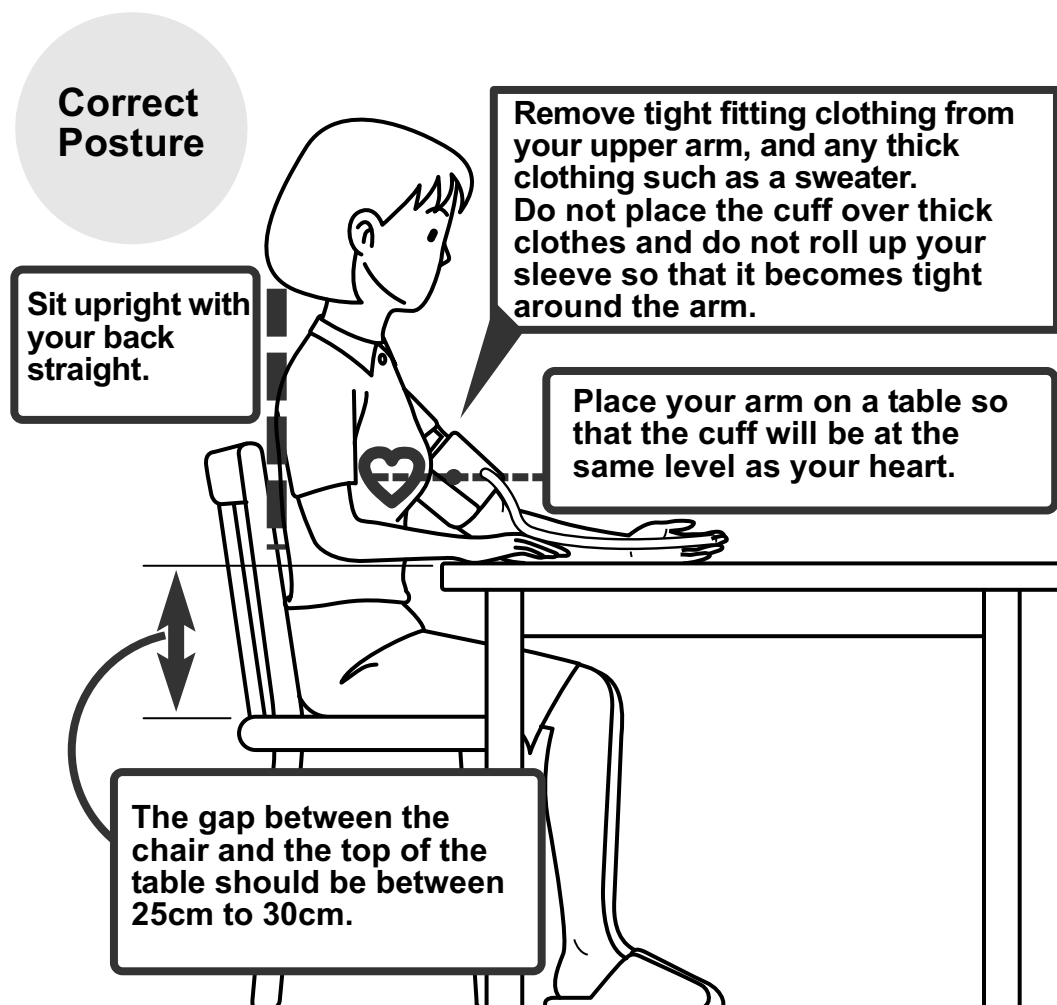

EN

Note: You can take a measurement on either your left or right arm. The blood pressure can differ between the right arm and the left arm and therefore also the measured blood pressure values can be different. OMRON recommends to always use the same arm for measurement. If the values between the two arms differ substantially, please check with your physician which arm to use for your measurement.

Incorrect Posture

- Arched back (leaning forwards)
- Sitting cross-legged
- Sitting on a sofa or at a low table so that you tend to lean forward



These situations could lead to higher blood pressure values due to strain or the arm cuff being lower than the heart.

If the arm cuff is at a lower position than your heart use cushions etc., to adjust the height of your arm.

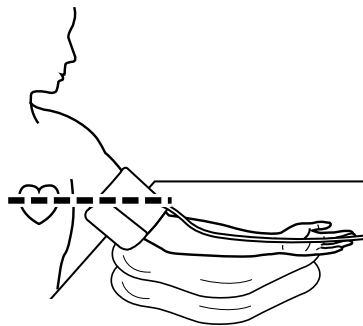

3.2 Applying the Arm Cuff

Be sure to wrap the arm cuff correctly so that you get accurate results. Measurements can be taken in light clothing. However, please remove thick clothes, such as sweaters, before taking a reading.

1. Insert the air plug into the air jack on the left side of the main unit.

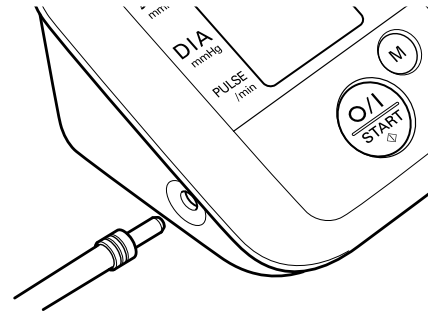

2. Put your left arm through the cuff loop.

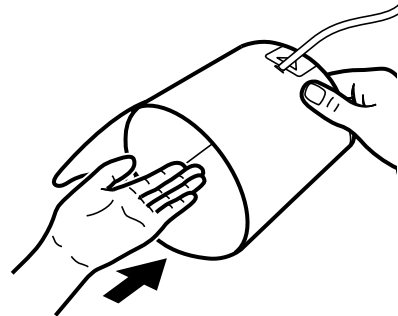

Note: If the cuff is not assembled, pass the end of the cuff furthest from the tubing through the metal D-ring to form a loop. The smooth cloth should be on the inside of the cuff loop.

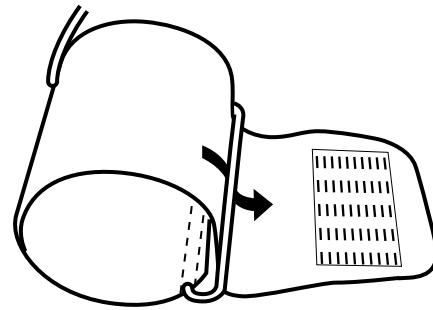

EN

3. Position the arm correctly.

- 1) The air tube should run down the inside of your forearm and be in line with your middle finger.
- 2) The bottom of the cuff should be approximately 1 to 2 cm above your elbow.
- 3) Apply the cuff to your upper arm so that the marker (arrow under tube) is centered on the middle of your inner arm and points down the inside of the arm.

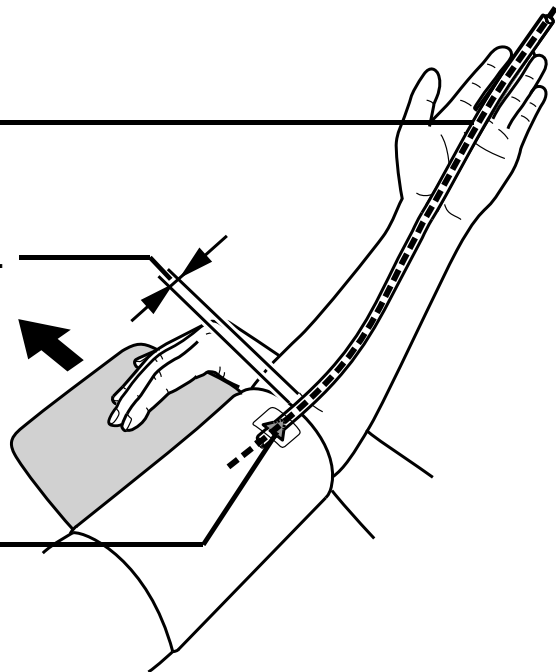

Taking Measurements on the Right Arm

Apply the cuff so that the air tube is at the side of your elbow.

- Be careful not to rest your arm on the air tube, or otherwise restrict the flow of air to the cuff.
- The cuff should be 1 to 2 cm above the elbow.

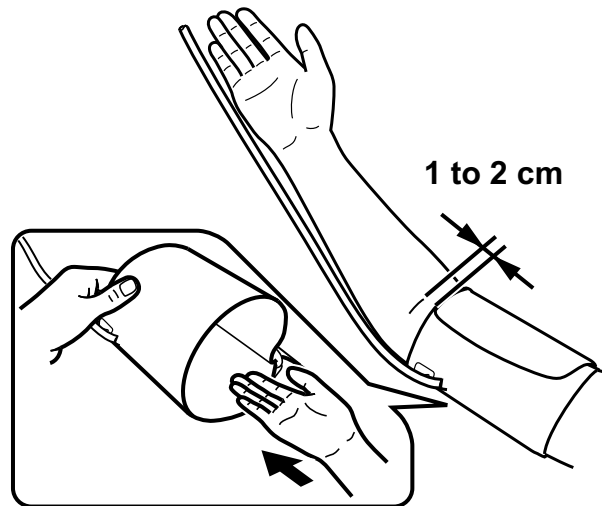

4. When the cuff is positioned correctly, close the fabric fastener **FIRMLY**.

3.3 Taking a Reading

1. Press the O/I START button to turn the unit on.
The cuff starts to inflate automatically.

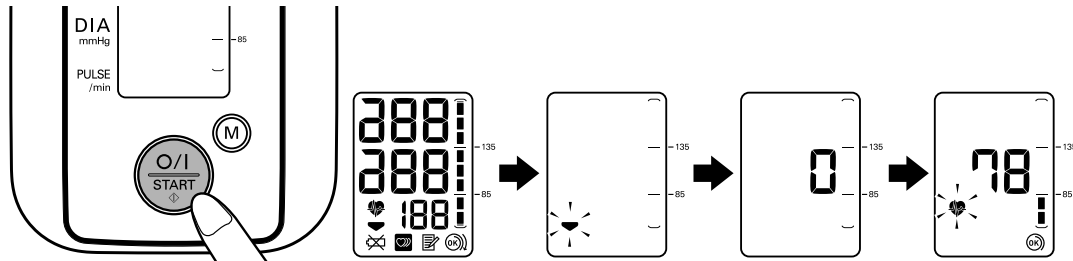

Sit in a chair with your feet flat on the floor and place your arm on a table so that the cuff will be at the same level as your heart. Keep still and do not talk during measurement.

Note: To cancel a measurement, press the O/I START button to turn the unit off and to release the air in the arm cuff.

Cuff Wrapping Guide

The Cuff Wrapping Guide is a unique feature that indicates if the cuff is not wrapped tightly enough around the arm.

Even when the  is displayed, a blood pressure reading will be taken.

Note: This reading is NOT reliable due to the incorrect wrapping of the cuff. Please wrap the cuff again, taking care to wrap it correctly and take the measurement again.

When the  is displayed, the cuff is correctly wrapped tightly enough on the arm and the reading is accurate and reliable.

2. Inflation stops and the measurement starts with deflating. As the cuff deflates, the heartbeat symbol () flashes at every heartbeat.
3. When the measurement is complete, the arm cuff completely deflates. Your blood pressure and pulse rate are displayed.

4. Check the measurement results.

The unit automatically stores blood pressure and pulse rate into its memory. Refer to “3.5 Using the Memory Function”.

Systolic blood pressure

Diastolic blood pressure

Pulse display

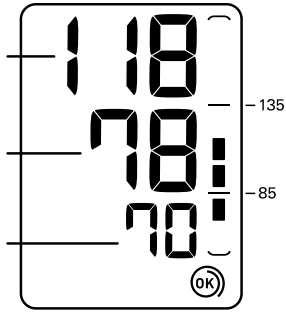

Note: Wait 2-3 minutes before taking another blood pressure measurement. Waiting between readings allows the arteries to return to the condition prior to taking the blood pressure measurement.

⚠ Warning:

Self-diagnosis of measured results and treatment are dangerous. Please follow the instructions of your doctor.

Common Causes of Inaccurate Results

Arm cuff is too loose.

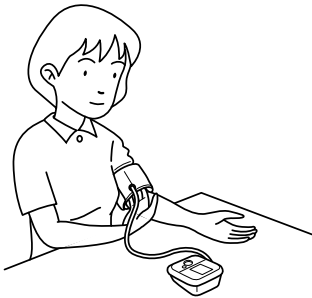

Movement or talking during measurement.



Leaning forwards.



Note: If the arm cuff is at a lower position than your heart use cushions etc., to adjust the height of your arm.

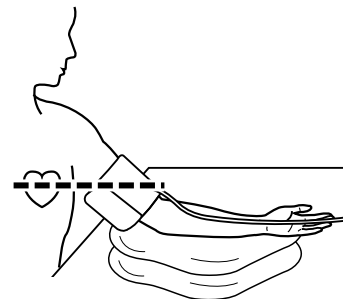

5. Remove the arm cuff.

6. Press the O/I START button to turn the unit off.

Note: If you forget to turn the unit off, it will automatically shut itself off after five minutes.

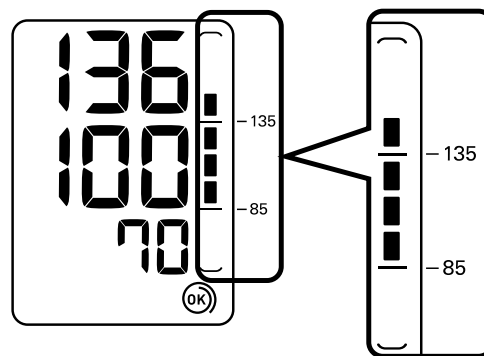

Important:

Recent research suggests that the following values can be used as a guide to high blood pressure for measurements taken at home.



Systolic Blood Pressure	Above 135 mmHg
Diastolic Blood Pressure	Above 85 mmHg

This criteria is for home blood pressure measurement. For professional office blood pressure measurement criteria, please refer to Chapter 9 “Some Useful Information about Blood Pressure”.

- Your blood pressure monitor includes an irregular heartbeat feature. Irregular heartbeats can influence the results of the measurement. The irregular heartbeat algorithm automatically determines if the measurement is usable or needs to be repeated. If the measurement results are affected by irregular heartbeats but the result is valid, the result is shown together with the irregular heartbeat symbol (). If the irregular heartbeats cause the measurement to be invalid, no result is shown. If the irregular heartbeat symbol () is shown after you have taken a measurement, repeat the measurement. If the irregular heartbeat symbol () is shown frequently, please make your doctor aware of it.

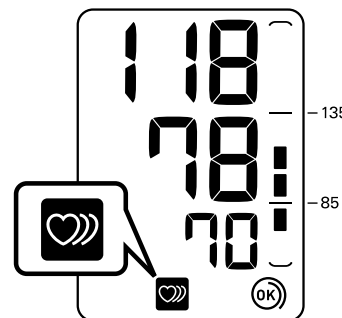

What is Irregular Heartbeat?

An irregular heartbeat is a heartbeat rhythm that varies by more than 25% from the average heartbeat rhythm detected while the unit is measuring the systolic and diastolic blood pressure.

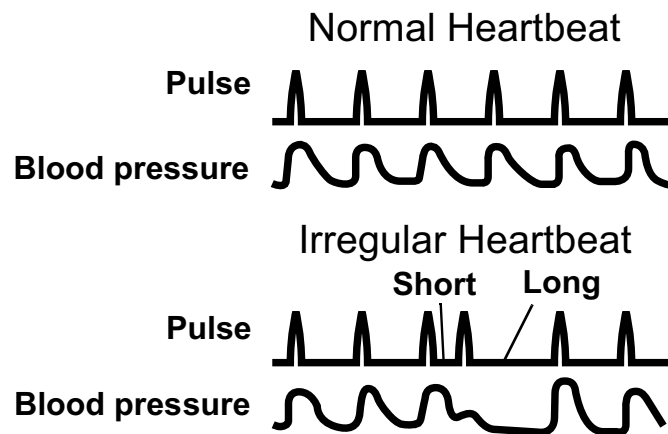

If such an irregular rhythm is detected more than twice during measurement, the irregular heartbeat symbol () appears on the symbol when the measurement results are displayed.

What is Arrhythmia?

A heartbeat is stimulated by electrical signals that cause the heart to contract.

Arrhythmia is a condition where the heartbeat rhythm is abnormal due to flaws in the bio-electrical system that drives the heartbeat. Typical symptoms are skipped heartbeats, premature contraction, an abnormally rapid (tachycardia) or slow (bradycardia) pulse. This can be caused by heart disease, aging, physical predisposition, stress, lack of sleep, fatigue etc. Arrhythmia can only be diagnosed by a doctor through a special examination.

Whether the appearance of the irregular heartbeat symbol () in the results indicates arrhythmia or not can only be determined by an examination and diagnosis by your doctor.

⚠ Warning:

If the irregular heartbeat symbol () is shown frequently, please make your doctor aware of it. Conducting self-diagnosis and treatment based on measurement results is dangerous. Be sure to follow the instructions of your doctor.

3.4 Instructions for Special Conditions

If your systolic pressure is known to be more than 220 mmHg, press and hold the O/I START button until the arm cuff inflates 30 to 40 mmHg higher than your suspected systolic pressure.

-
1. Press the O/I START button to turn the unit on.
Measurement starts.

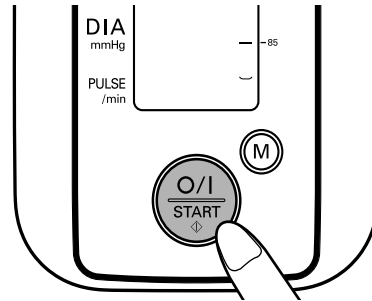

-
2. When the cuff starts to inflate, press the O/I START button and keep it pressed until the pressure is 30 to 40 mmHg higher than your suspected systolic pressure.

Note: You cannot inflate the cuff above 299 mmHg. (An error will be displayed if you try to inflate the cuff above 299 mmHg.)

-
3. Release the O/I START button when the cuff has been inflated to the desired pressure.

The cuff starts to deflate and measurement starts.

-
4. The rest of the procedure is the same as for normal measurement. Refer to 3.3, steps 2 to 6.

Note: Do not apply more pressure than necessary.

3.5 Using the Memory Function

The unit automatically stores up to 21 sets of measurement values (blood pressure and pulse rate). When 21 sets of measurement values are stored, the oldest record is deleted to save the most recent values.

1. Press the M button.

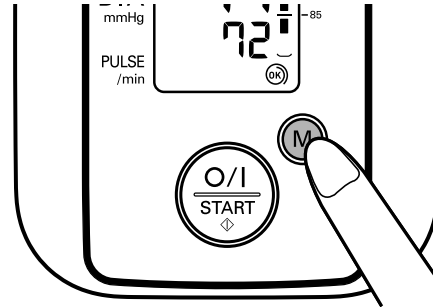

Note: If there are no measurements results stored in memory, the screen to the right is displayed.

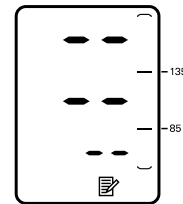

2. Press the M button repeatedly to cycle through the previous measurement results.

The Memory number appears for a second before the pulse rate is displayed.

The newest set is numbered "1".

At the end of the measurement, if an irregular heartbeat is detected, the irregular heartbeat symbol will be displayed with the result.

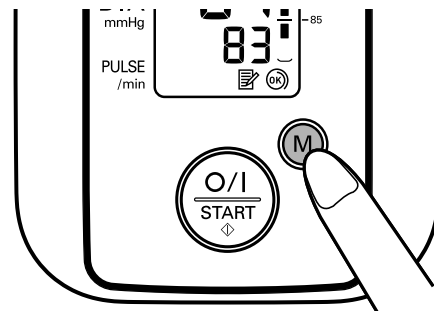

EN

3. Press the O/I START button to turn the unit off.

Note: If you forget to turn the unit off, it will automatically shut itself off after five minutes.

To Delete All the Values Stored in Memory

You cannot delete individual stored readings, all the readings in the unit will be deleted.

1. To delete stored readings, first press the M button. Then while holding it down, press the O/I START button simultaneously for about 2-3 seconds. All readings will then be deleted.

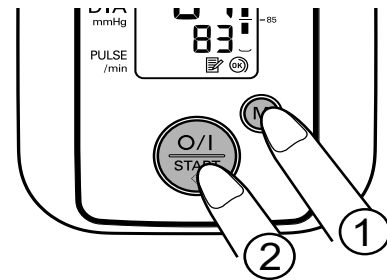

Important: Be careful not to press the O/I START button first. If the O/I START button is pressed first, measurement will start.

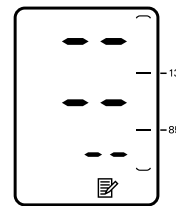

2. Press the O/I START button to turn the unit off.

Note: If you forget to turn the unit off, it will automatically shut itself off after five minutes.

4. Quick Reference Guide

If you are using this device for the first time, please read carefully chapter 3 of this instruction manual. To help ensure a reliable reading, avoid eating, drinking alcohol, smoking, or exercising for at least 30 minutes before taking a measurement.

Note: Remove any tight-fitting clothing from your upper arm.

1. Sit on a chair with your feet flat on the floor and place your arm on a table so that the arm cuff will be at the same level as your heart.

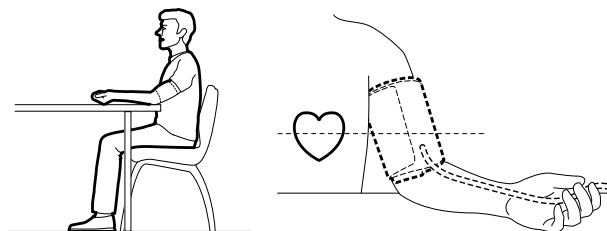

2. Apply the arm cuff to your upper arm. The marker should be centred on the inside of your arm and point down the inside of the arm, so that the air tube runs down the inside of your forearm and is in line with your middle finger.

3. Secure the cuff around your arm using the fabric fastener strip.

4. Press the O/I START button.

When measurement is complete, the monitor displays your blood pressure and pulse rate, and automatically deflates the cuff.

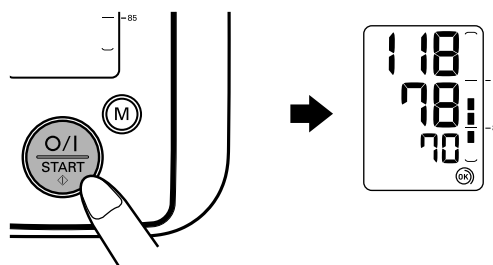

Notes:



- Always wait at least 2-3 minutes before taking another blood pressure measurement.
- Please note that all measurements are stored in the memory. If different people measure with the same device make sure that you are aware of this fact.

EN

5. Handling Errors and Problems

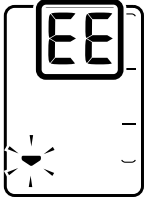
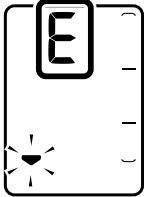
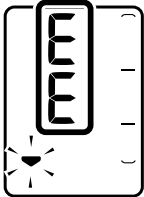
5.1 Error Messages

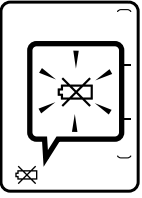
Error Display	Cause	Remedy
	Cuff is under inflated.	Carefully read and repeat the steps listed under section 3.4.
	Movement during measurement.	Repeat measurement. Remain still and do not talk during measurement. Refer to section 3.3.
	Air plug disconnected.	Insert the air plug securely. Refer to section 3.2.
	Arm cuff not applied correctly.	Apply the arm cuff correctly. Refer to section 3.2.
	Clothing is interfering with the arm cuff.	Remove any clothing interfering with the arm cuff. Refer to section 3.2.
	Air is leaking from the arm cuff.	Replace cuff with new one. Refer to Chapter 7.
	The arm cuff was inflated above 299 mmHg when inflating the cuff manually.	Do not inflate the arm cuff above 299 mmHg. Refer to section 3.4.

Error Display	Cause	Remedy
 <p data-bbox="256 464 456 562">Blinks or appears continuously</p>	<p data-bbox="542 365 857 401">Battery power is low.</p>	<p data-bbox="924 327 1295 443">Replace all four “AAA” batteries with new ones. Refer to section 2.1.</p>
	<p data-bbox="542 636 737 672">Device error.</p>	<p data-bbox="924 621 1349 695">Contact your OMRON retail outlet or distributor.</p>

Note: The irregular heartbeat symbol () may also be displayed with error messages.

5.2 Troubleshooting

Problem	Cause	Remedy
The reading is extremely low (or high).	Arm cuff not applied correctly.	Apply the arm cuff correctly. Refer to section 3.2.
	Movement or talking during measurement.	Remain still and do not talk during measurement. Refer to section 3.3.
	Clothing is interfering with the arm cuff.	Remove any clothing interfering with the arm cuff. Refer to section 3.1.
Arm cuff pressure does not rise.	The air plug is not securely inserted into the main unit.	Make sure that the air plug is connected securely. Refer to section 3.2.
	Air is leaking from the arm cuff.	Replace the arm cuff with a new one. Refer to Chapter 7.
Arm cuff deflates too soon.	The arm cuff is loose.	Apply the cuff correctly so that it is firmly wrapped around the arm. Refer to section 3.2.
Cannot measure or readings are too low or too high.	The arm cuff has not been inflated sufficiently.	Inflate the cuff so that it is 30 to 40 mmHg above your previous measurement result. Refer to section 3.4.
The unit loses power during measurement.	The batteries are empty.	Replace the batteries with new ones.

Problem	Cause	Remedy
Nothing happens when you press the buttons.	The batteries are empty.	Replace the batteries with new ones.
	The batteries have been inserted incorrectly.	Insert the batteries with the correct (+/-) polarity.
Other problems.	Press the O/I START button and repeat measurement. If the problem continues, try replacing the batteries with new ones. If this still does not solve the problem, contact your OMRON retail outlet or distributor.	

6. Maintenance and Storage

Maintenance

To protect your unit from damage, please observe the following:

- Do not subject the main unit and cuff to extreme temperatures, humidity, moisture or direct sunlight.
- Do not fold the cuff or tubing tightly.
- Do not disassemble the unit.
- Do not subject the unit to strong shocks or vibrations (for example, dropping the unit on the floor).
- Do not use volatile liquids to clean the main unit.
- Do not wash the arm cuff or immerse it in water.
- Do not use petrol, thinners or similar solvents to clean the arm cuff.
- Do not carry out repairs of any kind by yourself. If a defect occurs, consult your OMRON retail outlet or distributor as mentioned on the packaging.

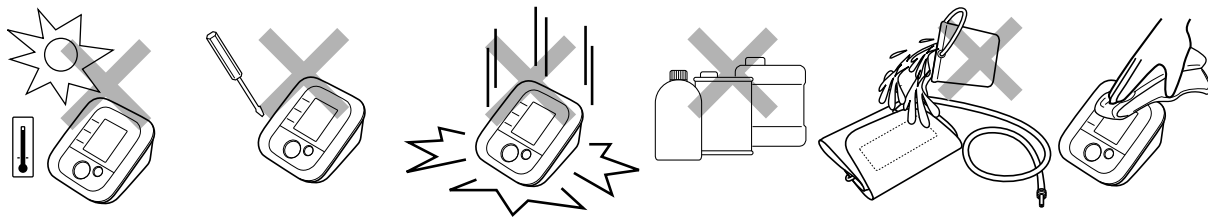

- The unit should be cleaned with a soft, dry cloth.
- Use a soft, moistened cloth and soap to clean the arm cuff.

Calibration and Service

- The accuracy of this blood pressure monitor has been carefully tested and is designed for a long service life.
- It is generally recommended to have the unit inspected every two years to ensure correct functioning and accuracy. Please consult your authorised OMRON dealer.

Storage

Keep the unit in its storage case when not in use.

1. Unplug the air tube from the air jack.

Gently fold the air tube into the arm cuff.

Note: Do not bend the air tube excessively.

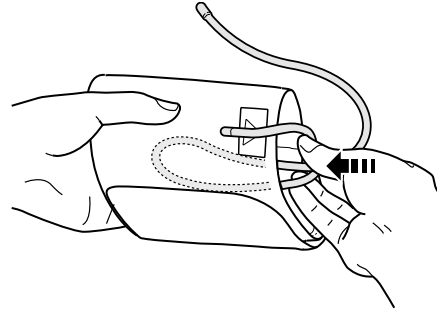

2. Place the arm cuff and main unit in the storage case.

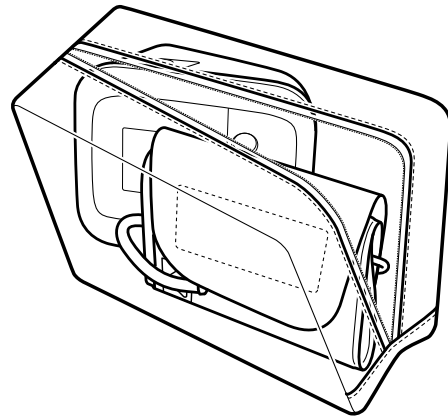

Do not store the unit in the following situations:

- If the unit is wet.
- Locations exposed to extreme temperatures, humidity, direct sunlight, dust or corrosive vapours.
- Locations exposed to vibrations, shocks or where it will be at risk of falling.

EN

7. Optional Parts

Wide Range Cuff

Arm circumference 22 - 42 cm

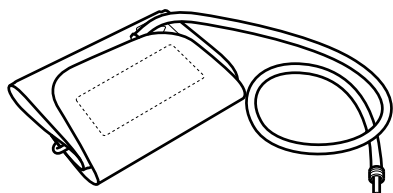

CW-9520534-2 (Model: HEM-RML30)

Medium Arm Cuff

Arm circumference 22 - 32 cm

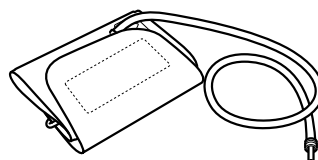

CM2-9513256-6

Large Arm Cuff

Arm circumference 32 - 42 cm

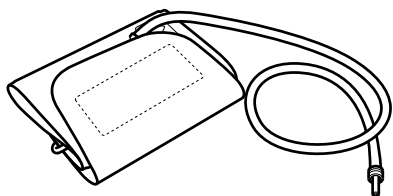

CL2-9513255-8

AC Adapter S

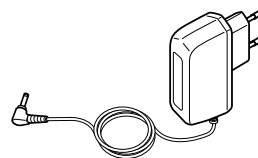

Adapter S-9515336-9

Using the Optional AC Adapter

Insert batteries into the battery compartment even when using the AC adapter.

Notes:

- Never plug or unplug the power cord with wet hands.
- Use only the original AC adapter designed for this unit. Use of unsupported adapters may damage the unit.
- When storing the optional AC adapter with the main unit, be careful not to damage the main unit or cuff.

1. Insert the AC adapter plug into the AC adapter jack on the right side of the main unit.

2. Plug the AC adapter into an electrical outlet.

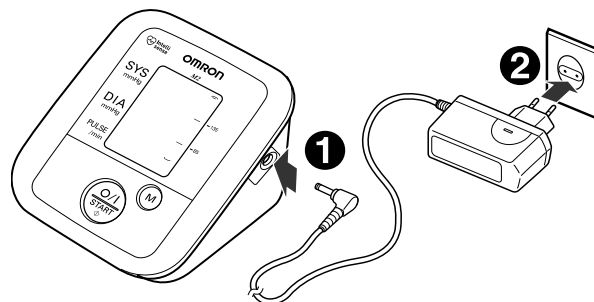

To disconnect the AC adapter, unplug the AC adapter from the electrical outlet first and then immediately remove the AC adapter plug from the main unit.

8. Technical Data

Product Description	Digital Automatic Blood Pressure Monitor
Model	OMRON M2 (HEM-7119-E(V))
Display	LCD Digital Display
Measurement Method	Oscillometric method
Measurement Range	Pressure: 0 mmHg to 299 mmHg Pulse: 40 to 180/min.
Memory	21 Measurements
Accuracy	Pressure: ± 3 mmHg Pulse: $\pm 5\%$ of display reading
Inflation	Automatic by electric pump
Deflation	Automatic pressure release valve
Power Source	4 "AAA" batteries 1.5V or AC/ DC adapter (optional, 6V = 4W)
Battery Life	Capacity of new alkaline batteries is approx. 300 measurements
Operating Temperature/ Humidity	10°C to 40°C/ 30 to 85% RH
Storage Temperature/ Humidity/ Air Pressure	-20°C to 60°C/ 10 to 95% RH/ 700-1060 hPa
Console Weight	Approximately 250g without batteries
Cuff Weight	Approximately 120g
Outer Dimensions	Approximately 104 (w) mm \times 84 (h) mm \times 129 (l) mm
Cuff Dimensions	Approximately 146 mm \times 446 mm (Medium cuff: arm circumference 22 to 32 cm)
Cuff material	Nylon and polyester
Package Content	Main unit, cuff, instruction manual, storage case, battery set, guarantee card, blood pressure pass

EN

Note: Subject to technical modification without prior notice

- This OMRON product is produced under the strict quality system of OMRON HEALTHCARE Co. Ltd., Japan. The Core component for OMRON blood pressure monitors, which is the Pressure Sensor, is produced in Japan.
- Disposal of this product and used batteries should be carried out in accordance with the national regulations for the disposal of electronic products.

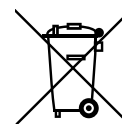

= Type B

CE 0197

This device fulfils the provisions of EC directive 93/42/EEC (Medical Device Directive). This blood pressure monitor is designed according to the European Standard EN1060, Non-invasive sphygmomanometers Part 1: General Requirements and Part 3: Supplementary requirements for electromechanical blood pressure measuring systems.



Caution: Please read the instruction manual carefully before using the device.

Important information regarding Electro Magnetic Compatibility (EMC)

With the increased number of electronic devices such as PC's and mobile (cellular) telephones, medical devices in use may be susceptible to electromagnetic interference from other devices. Electromagnetic interference may result in incorrect operation of the medical device and create a potentially unsafe situation.

Medical devices should also not interfere with other devices.

In order to regulate the requirements for EMC (Electro Magnetic Compatibility) with the aim to prevent unsafe product situations, the EN60601-1-2:2007 standard has been implemented. This standard defines the levels of immunity to electromagnetic interferences as well as maximum levels of electromagnetic emissions for medical devices.

This medical device manufactured by OMRON HEALTHCARE conforms to this EN60601-1-2:2007 standard for both immunity and emissions.

Nevertheless, special precautions need to be observed:

- Do not use mobile (cellular) telephones and other devices, which generate strong electrical or electromagnetic fields, near the medical device. This may result in incorrect operation of the unit and create a potentially unsafe situation. Recommendation is to keep a minimum distance of 7 m. Verify correct operation of the device in case the distance is shorter.

Further documentation in accordance with EN60601-1-2:2007 is available at OMRON HEALTHCARE EUROPE at the address mentioned in this instruction manual.

Documentation is also available at www.omron-healthcare.com.

Correct Disposal of This Product (Waste Electrical & Electronic Equipment)

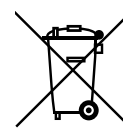

This marking shown on the product or its literature, indicates that it should not be disposed of, with other household wastes at the end of its working life. To prevent possible harm to the environment or human health from uncontrolled waste disposal, please separate this product from other types of wastes and recycle it responsibly to promote the sustainable reuse of material resources.

Household users should contact either the retailer where they purchased this product, or their local government office, for details of where and how they can return this item for environmentally safe recycling.

Business users should contact their supplier and check the terms and conditions of the purchase contract. This product should not be mixed with other commercial wastes for disposal.

9. Some Useful Information about Blood Pressure

What is Blood Pressure?

Blood pressure is a measure of the force of blood flowing against the walls of the arteries. Arterial blood pressure is constantly changing during the course of the heart's cycle.

The highest pressure in the cycle is called the *Systolic Blood Pressure*; the lowest is the *Diastolic Blood Pressure*.

Both pressure readings, the *Systolic* and *Diastolic*, are necessary to enable a doctor to evaluate the status of a patient's blood pressure.

Why is it a Good Thing to Measure Blood Pressure at Home?

Having your blood pressure measured by a doctor can cause anxiety which is itself a cause of high blood pressure. As a variety of conditions affect blood pressure, a single measurement may not be sufficient for an accurate diagnosis.

Many factors such as physical activity, anxiety, or the time of day, can influence your blood pressure. Thus it is best to try and measure your blood pressure at the same time each day, to get an accurate indication of any changes in blood pressure. Blood pressure is typically low in the morning and increases from afternoon to evening. It is lower in the summer and higher in the winter.

Blood pressure is measured in millimetres of mercury (mmHg) and measurements are written with the systolic pressure before the diastolic e.g. A blood pressure written as 135/85, is referred to as 135 over 85 mmHg.

EN

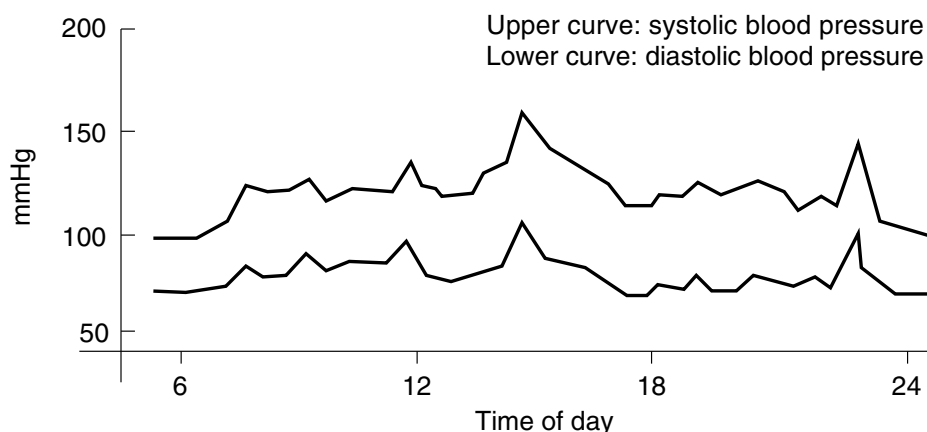

Example: fluctuation within a day (male, 35 years old)

Classification of Blood Pressure by the World Health Organization

The World Health Organization (WHO) and the International Society of Hypertension (ISH) developed the Blood Pressure Classification shown in this figure.

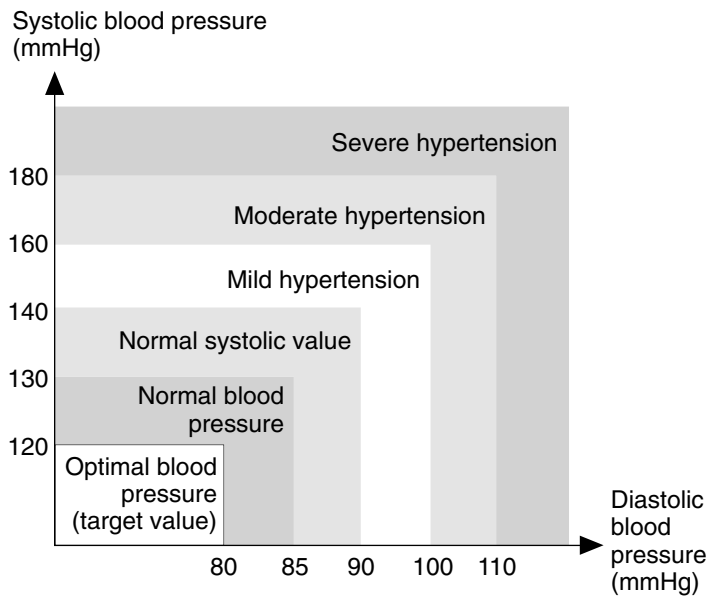

This classification is based on the blood pressure values measured on people in a sitting position in outpatient departments of hospitals.

Note: There is no universally accepted definition of hypotension. However, those having the systolic pressure below 100 mmHg are assumed as hypotensive.

Manufacturer 	OMRON HEALTHCARE Co., Ltd. 53, Kunotsubo, Terado-cho, Muko, Kyoto, 617-0002 JAPAN		
EU-representative <table border="1" data-bbox="191 443 456 554"> <tr> <td data-bbox="191 443 321 554">EC</td> <td data-bbox="321 443 456 554">REP</td> </tr> </table>	EC	REP	OMRON HEALTHCARE EUROPE B.V. Scorpius 33, 2132 LR Hoofddorp THE NETHERLANDS www.omron-healthcare.com
EC	REP		
Production facility	OMRON HEALTHCARE MANUFACTURING VIETNAM CO., LTD. No. 28 VSIP II, Street 2, Vietnam-Singapore Industrial Park II, Binh Duong Industry-Services-Urban Complex Hoa Phu Ward, Thu Dau Mot Town, Binh Duong Province, VIETNAM		
Subsidiary	OMRON HEALTHCARE UK LIMITED Opal Drive Fox Milne Milton Keynes, MK15 0DG U.K.		
	OMRON MEDIZINTECHNIK HANDELSGESELLSCHAFT mbH John-Deere-Str. 81a 68163 Mannheim, GERMANY www.omron-medizintechnik.de		
	OMRON Santé France SAS 14, rue de Lisbonne 93561 Rosny-sous-Bois Cedex FRANCE		

EN

Made in Vietnam